

R_{esson} Technologies

The People that Always Committed to Quality, Technology & Innovation

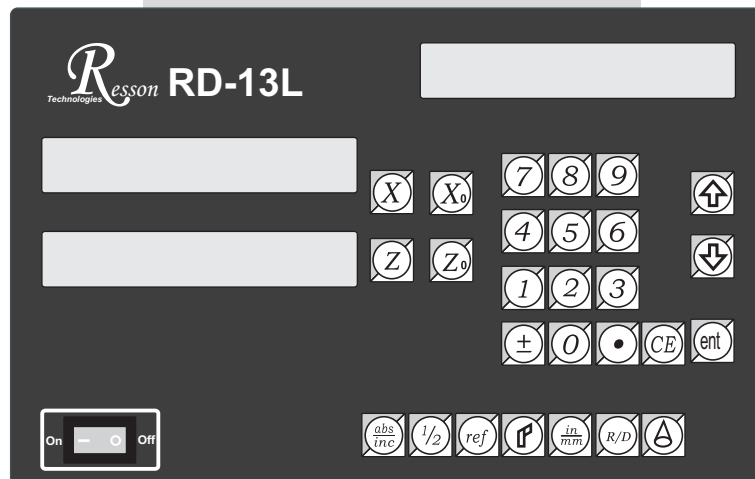

RD-13L

Digital Readout System
Operation Manual
(Lathe)

Resson Technologies Co., Ltd.

Precautions

For your protection, please read these safety instructions completely before operating the appliance.

- Selection of mains voltage
The Digital readout unit is supplied for 100V~230V, 50Hz/60Hz, 20W max operation.
Instructions prior to activation of unit
 1. Please ensure that the voltage rating corresponds to the mains supply prior to activation.
 2. If this unit is to be operated via an autotransformer from mains supply of higher voltage, it must be ensured that the low end of the transformer is connected to the neutral wire of mains.

 - The mains connector may only be inserted into a socket with earthing contact. The protective effect should not be cancelled by an extension lead without an earthed conductor. Any interruption of the earthed conductor either inside or outside of the unit or disconnection of the earthed conductor can render the equipment potentially dangerous. Any intentional break is not permissible.

 - Please install the Linear Encoder finish after that switch on the Digital Readout Unit. If switches on Digital Readout Unit before install the Linear Encoder not finished yet. This may cause electronic parts burnt away of the Linear Encoder.

 - Do not use the instrument in an extremely hot or humid place.

 - Do not use the instrument near strong magnetic or magnetic field noise place. This is the main reason that causes instrument error working.

 - Wipe the Digital readout unit surface with a soft cloth to remove fingerprints, dust, etc.

 - Clean the Digital readout unit surface with a soft cloth slightly moistened with Neutral purger to remove serious dirt.

 - Do not use the organic solvent products such as oil, diesel fuel, kerosene, alcohol, etc clean the Digital readout unit.

 - Do not use the Air guns fanned Digital readout unit and Linear Encoder accessories to let grease, dust or bits get into the Digital readout unit. This may cause the system working unstable and malfunction.
-

Content

1 Basic Functions	1
2 REF Datum Memory	8
3 Cone Measurement Function	13
4 Digital Readout Setup Function	17
5 RD-13L Specification	23

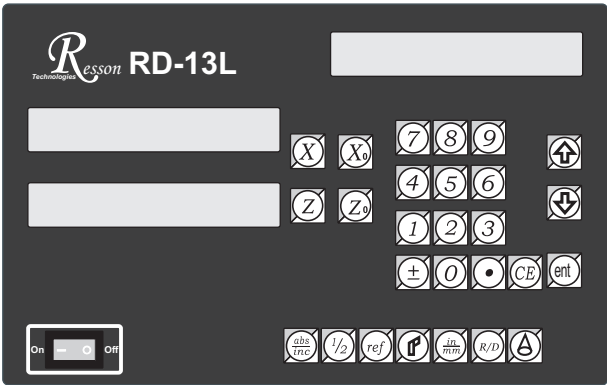
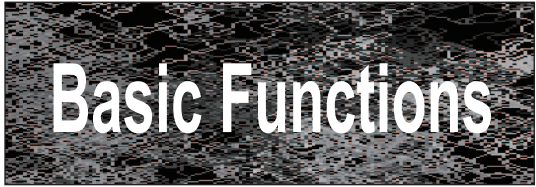

Purpose : Set the current position for that axis to zero

Example : To set the current **X Axis** position to **zero**

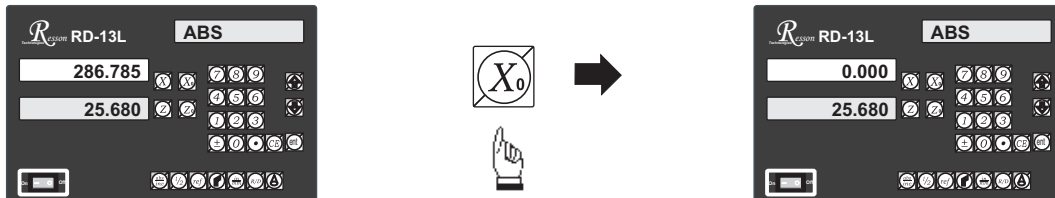

Inch / Metric Display Conversion

Purpose : Switches between inch and metric display

Example 1 : Currently in **inch** display, to switch to **metric** display

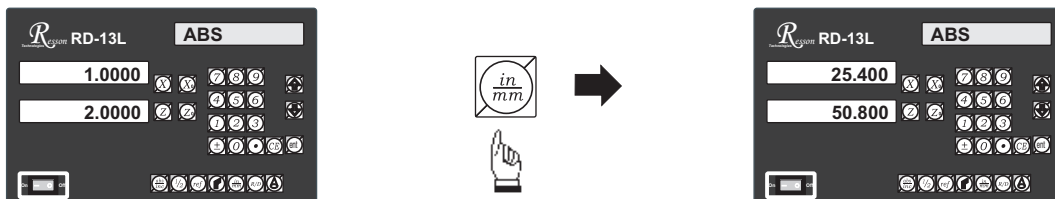

Example 2 : Currently in **metric** display, to switch to **inch** display

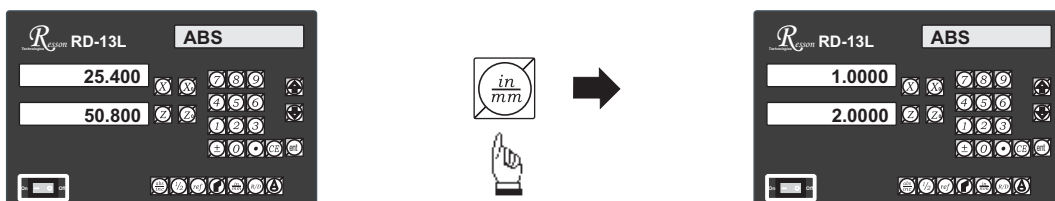

ABS / INC Coordinates display switches

Purpose : RD-15L provides two sets of basic coordinate display, they are **ABS** (absolute) and **INC** (incremental) displays.

During machining operations, the operator can *store the work piece datum (zero position)* in **ABS** coordinate, then switch to **INC** coordinate to continue machining operations.

The operator is then free to zero the axes or preset any dimensions into any axis in **INC** coordinate for relative position machining. The work piece datum (work piece zero position) is still retained in **ABS** coordinate by the **RD-15L**.

Operator can then toggle between **ABS** (absolute) and **INC** (incremental) coordinates without losing the work piece datum (work piece zero position).

Example 1 : Currently in **ABS** display coordinate, to switch to **INC** display coordinate

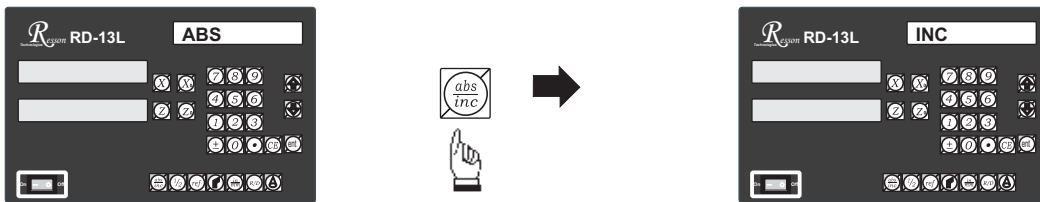

Example 2 : Currently in **INC** display coordinate, to switch to **ABS** display coordinate

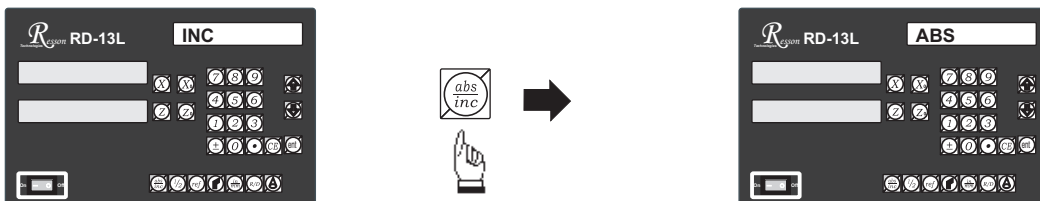

Purpose : During the machining on lathe, because the turned part's size reduced at twice as much as the actual X axis cross feed increment. Therefore, to obtain a direct diameter reading of the part that being machined, the readout offers Radius/Diameter display for X axis.

Example 1 : Currently in **Radius** display, to switch to **Diameter** display

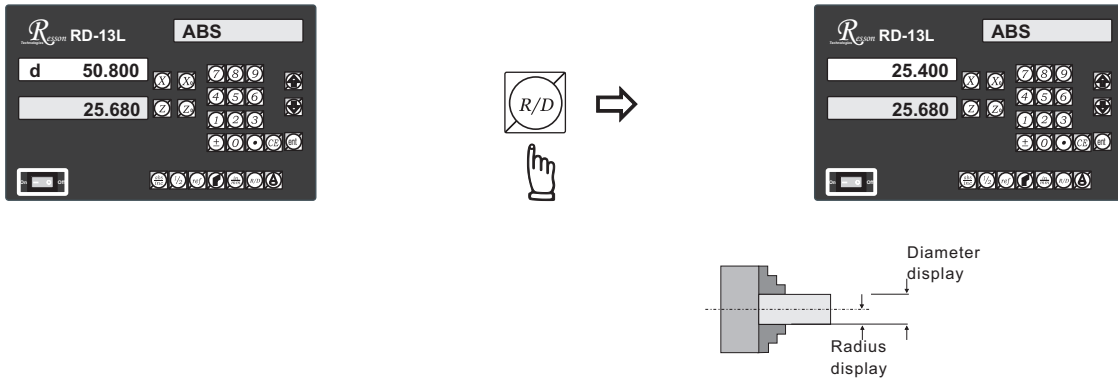

Example 2 : Currently in **Diameter** display, to switch to **Radius** display

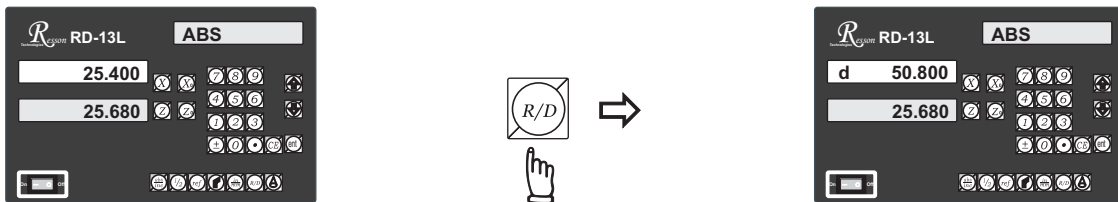

In Diameter display mode, the readout display double of the x axis increment.

During the Diameter display, a 'd' appears on the leftmost X axis digit display to indicate the readout is in Diameter display mode. Also, the display resolution is 0.01mm rather than 0.005mm as in Radius display mode.

Dimension Preset

Purpose : Set the current position for that axis to an entered Dimension

Example : To set the current X Axis position to 45.800mm

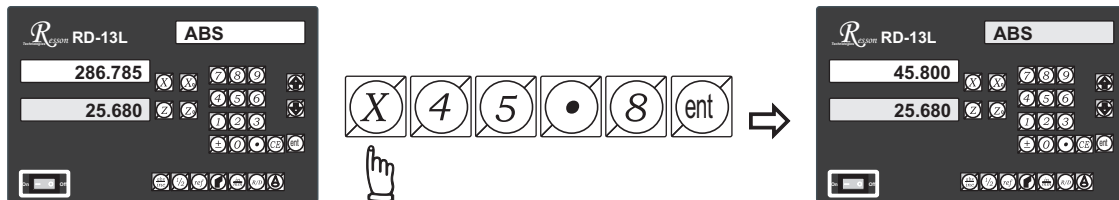

Application Tips : The dimension preset function provides a very convenience way to monitor your cross feed machining, the X axis machining.

- a) Switch the readout to Diameter (D) display for X axis.
- b) Make a slight first cut at the work piece, after finished this first cut, move the tool away from the work piece along the Z axis, it is important that don't move the X axis at all in order to keep the X axis right at the cut position.

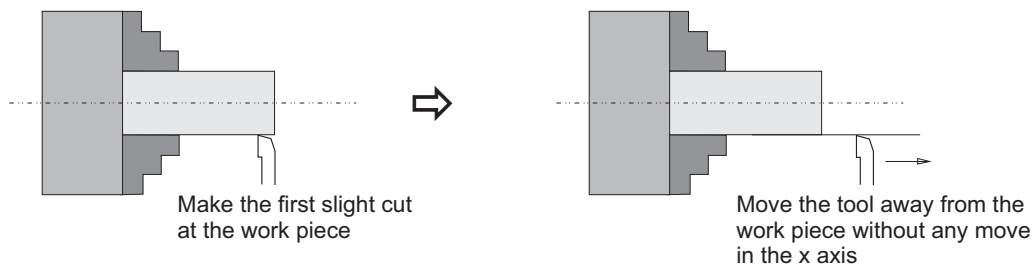

- c) measure the work piece by a caliper .(i.e. The measured diameter of the work piece is 45.80mm)

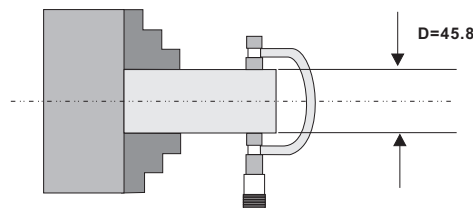

- d) Enter the measured diameter into the readout by the dimension preset function.

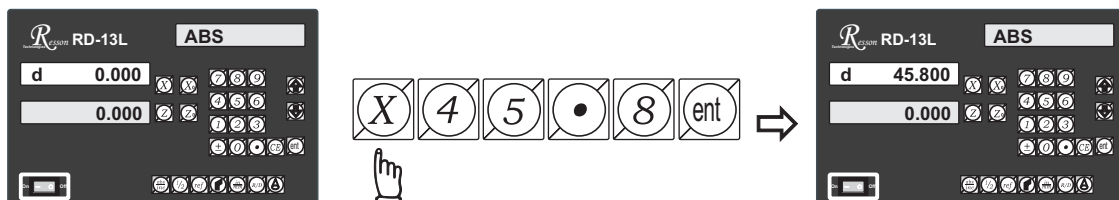

- e) Since the X axis tool position is now at the first cut position, by presetting the present tool position as the measured diameter, then from now on, whatever dimension shown on the readout is the actual diameter dimension in the work piece.

Purpose : Counter provide center find function by halving the current display coordinate, so that the zero point of the work piece is located at the center of the work piece.

Example : To set the Z Axis zero point at the center of the work piece

Step 1 : Locate the edge finder at one end of the work piece, then zero the Z Axis.

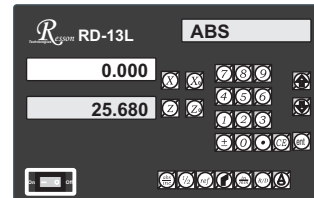
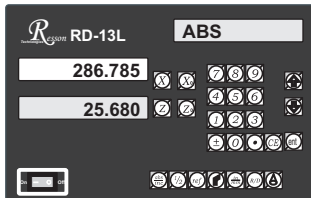
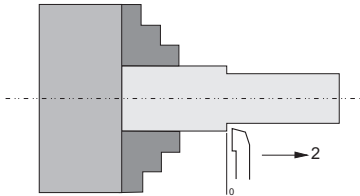

Step 2 : Locate the edge finder at the opposite end of the work piece.

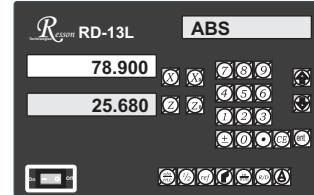
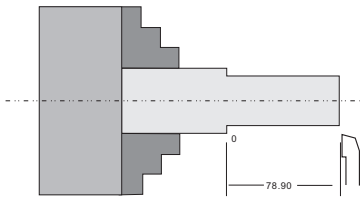

Step 3 : Then half the display coordinate using center find function as per follows

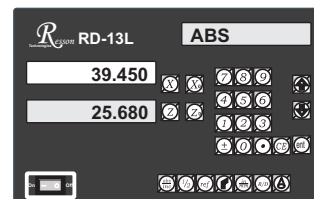
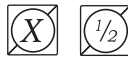
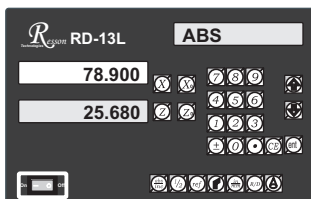

Now the Axis zero point (0.000) is located right at the Z center of the work piece.

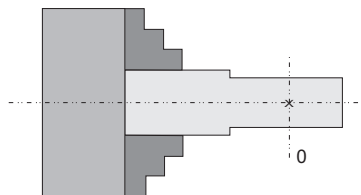

199 Tools memory

Purpose : The readout offer **199** Tools memory function, it is offered as a supplement of **ABS/INC** coordinates. For the lathe that have a high repeatability tool changer, this function provides a very quick ways to memory the tool tips offsets, so that user don't have to datum the tool tips.

Example 1 : Currently in INC display coordinate, to switch to TOOL 1 display coordinate.

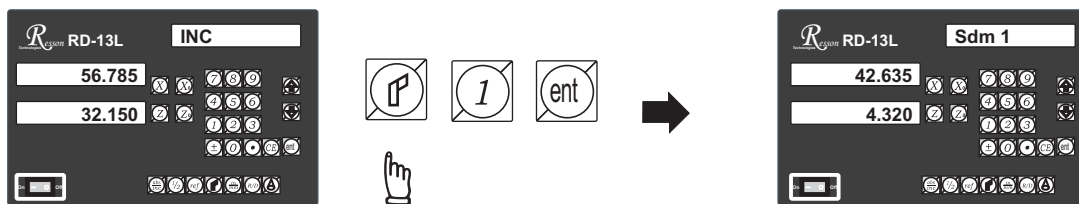

Example 2 : Currently in TOOL 1 display coordinate, to switch directly to TOOL 9 display coordinate.

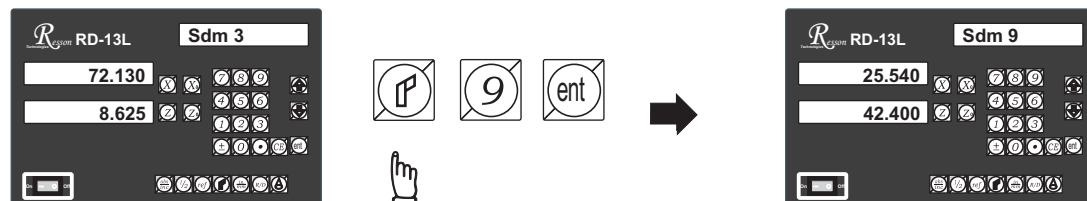

ref datum memory

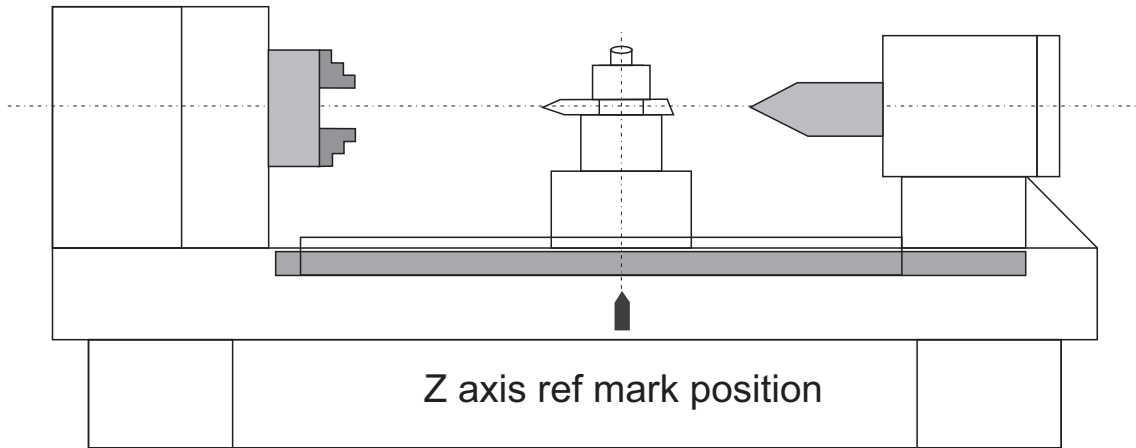

Function : During the daily machining process, it is very common that the machining cannot be completed within one work shift, and hence the DRO have to be switched off after work, or power failure happen during the machining process which is leading to lost of the work piece datum (work piece zero position), the re-establishment of work piece datum using edge finder or other method is inevitably induce higher machining inaccuracy because it is not possible to re-establish the work piece datum exactly at the previous position.

To allow the recovery of work piece datum very accurately and no need to re-establish the work piece datum using edge finder or other methods, every glass grating scale have a *ref* point location which is equipped with *ref* position to provide datum point memory function.

The working principal of the *ref* datum memory function are as follows.

-There are a permanent and fixed mark (position) in the centre of every glass grating scale, normally called *ref* mark or *ref* point.

Since this *ref* point position is permanent and fixed, it will never change or disappear when the DRO system is switched off. Therefore, we simply need to store the distance between the *ref* point and the work piece datum (zero position)in DRO's memory. Then in case of the power failure or Counter being switched off, we can recover the work piece datum (zero position) by presetting the display zero position as the stored distance from the *ref* point.

Example : to store the z axis work datum

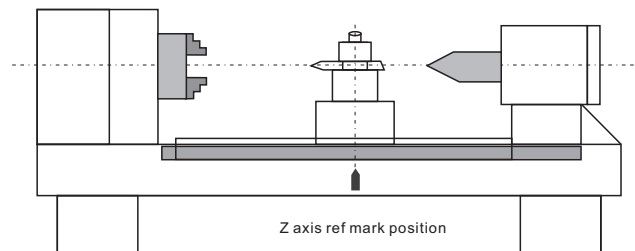

Operation : Counter provides one of the most easy to used *ref* datum memory function.

There is no need to store the relative distance between the *ref* mark and your work datum zero into Counter, whenever you alter the zero position of **ABS** coordinate , such as by zeroing, centre find, coordinate preset or etc., Counter will automatically store the relative distance between **ABS** zero and the *ref* mark location into Counter's memory.

In daily operation, operator simply need to find the *ref* mark position whenever they switch on the Counter to let Counter know where the *ref* mark position is, then Counter will automatically do the work datum storage on its' own whenever you alter the **ABS** zero position. In case power failure or the Counter switched off, the operator can recover the work piece datum easily by the **RECALL 0** procedure.

Function : Because in Counter's ref datum memory function, Counter will automatically store the relative distance between the *ref* mark position and the work piece datum (zero position) whenever the operator alter the **ABS** zero position, such as zeroing, centre find, coordinate preset or etc....

Therefore, Counter need to know where the *ref* mark position in prior to machining operation. In order to avoid the lost of work piece datum (zero position) during any accidental or unexpected events, such as power failure or etc...It is highly recommend that operator find the ref mark position using the (**FIND REF**)function whenever they switch on the Counter.

Step 1 : Enter into the ref function, select the **FIND REF** (find *ref* mark)

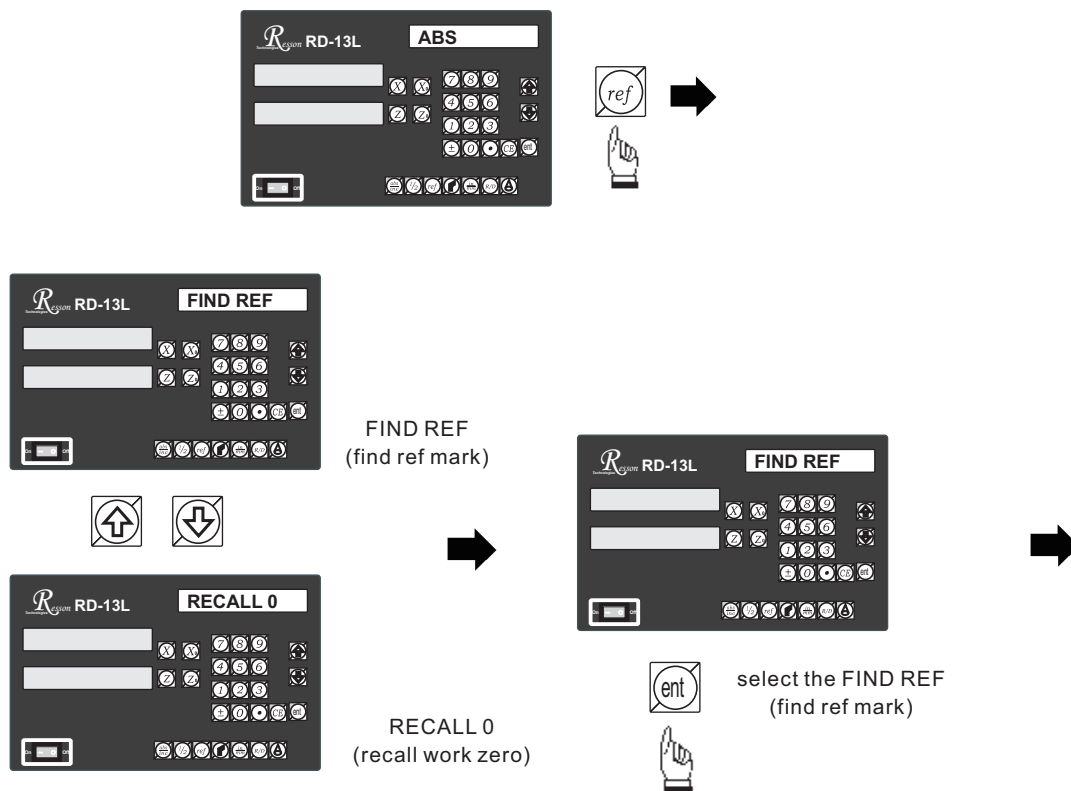

Step 2 : select the axis of which ref mark needed to be found

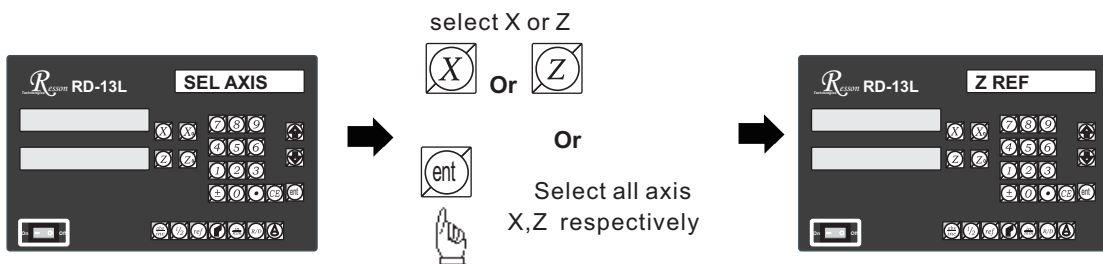

Find the scale's *ref* mark position (**FIND REF**)

Step 3 : Move the machine across the center of the glass grating scale until digits display in Counter start run.
select Z axis
in this example

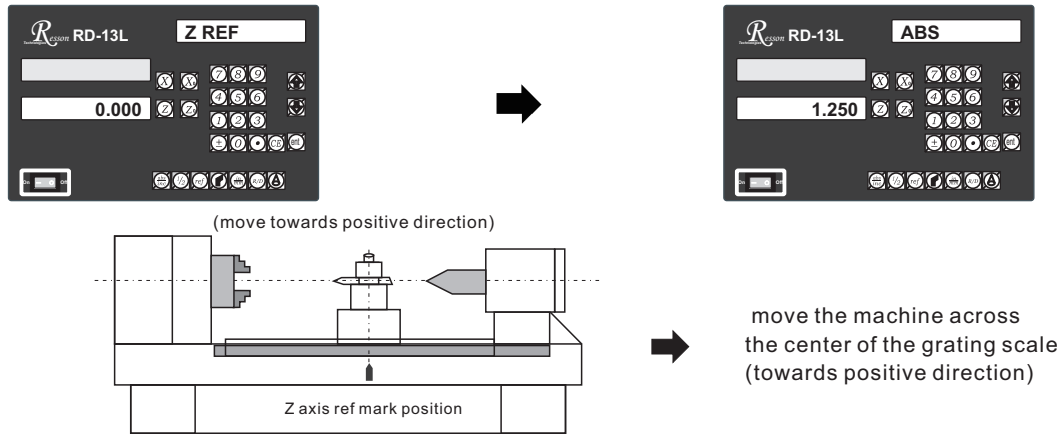

Recall the work datum zero (**RECALL 0**)

Function : after lost of the work piece datum due to power failure or switch off of Counter, the work piece datum can be recover by **RECALL 0** function as per following procedures.

Step 1 : enter into the *ref* function, select the **RECALL 0** (recall work piece zero)

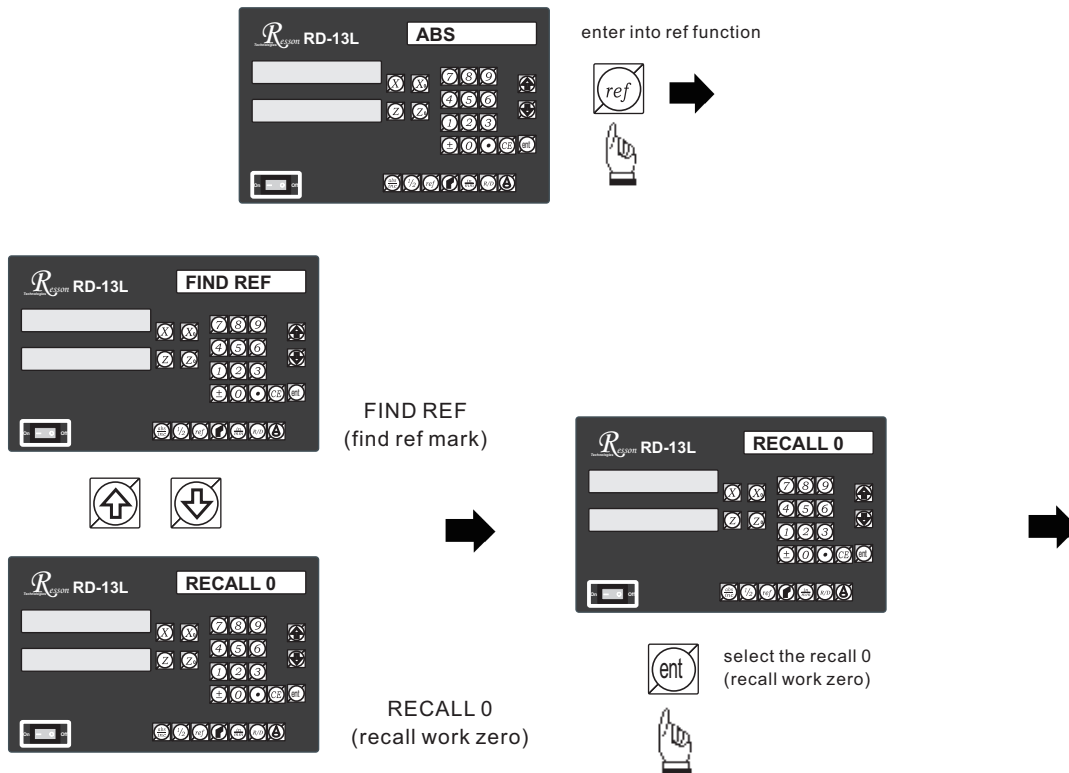

Step 2 : Select the axis of which work datum (zero position) needed to be recovered

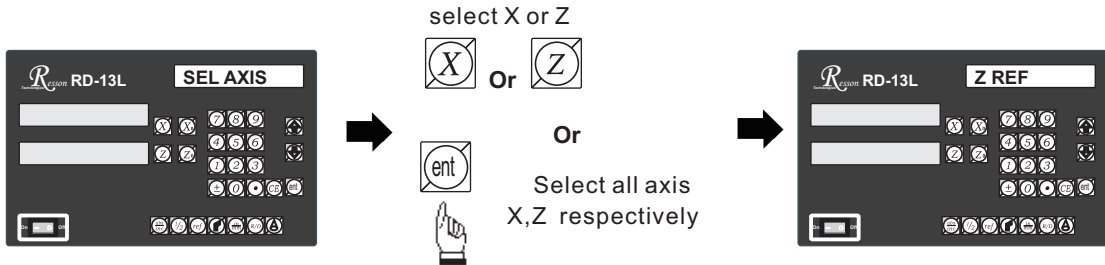

Step 3 : Move the machine across the centre of the glass grating scale until digits display in Counter start run, then work piece datum is recovered.

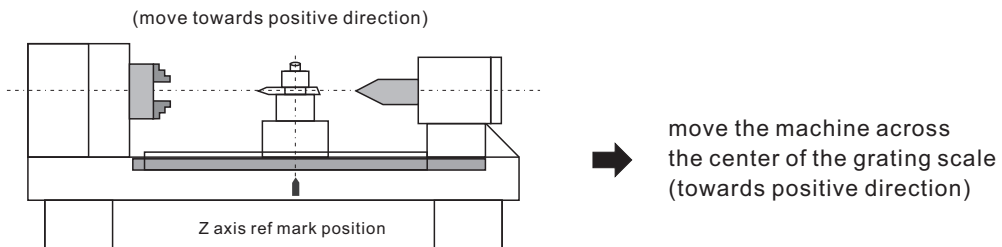
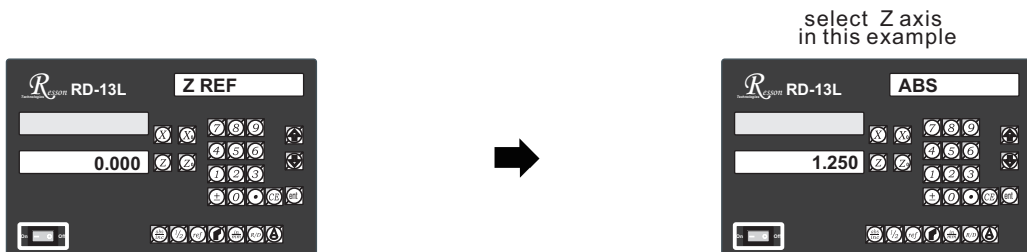

Cone- cone measurement function

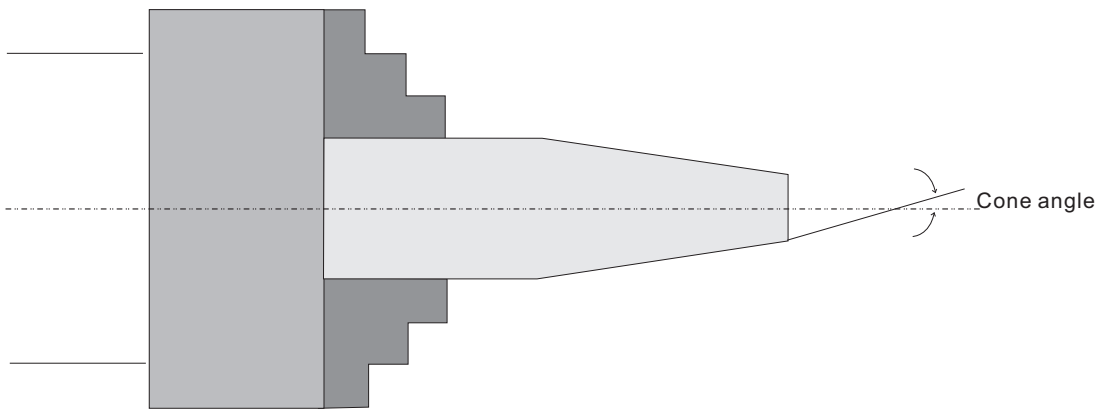

Cone- cone measurement function

Function : During daily lathe machining process, it is quite common to machine a conical work piece.

The readout provides cone measurement function for ease of conical work piece measurement.

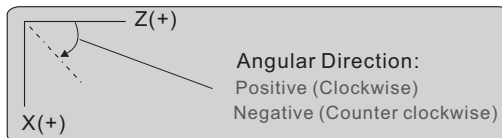
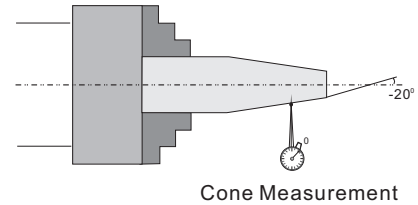

Example : Normally, the top slide on the cross slide of the lathe can be swing to an angle for conical machining, however, there are only a very inaccurate dial marked on this top slide. In order to obtain better conical machining accuracy, the readout offers cone measurement function for the ease of cone angle measurement to help user to obtain a better & faster iteration process.

For example, to verify a work piece that have been machined at 20 degree on the XZ plane as shown in follows.

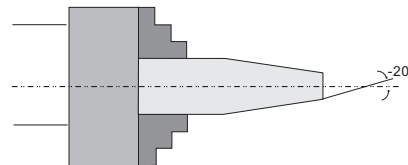

- To adjust the top slide on the cross slide of the lathe to 20 degree as accuracy as possible according to the dial marks on the cross slide, and then start the initial conical cutting, (please make sure to leave some metal for the final cut).
- Using a dial indicator to start the cone measurement as per following procedure. Set up the dial indicator as per following diagram suggested.

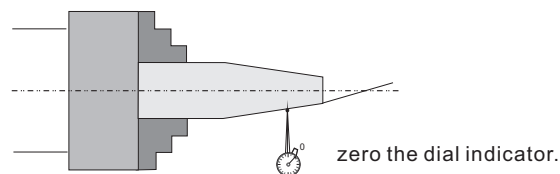

- Enter the cone measurement function and enter the -20 degree as the cone comparison parameter.

enter into CONE function

cone angle (INCLANG)=-20degree

enter incline angle (INCLANG)

CONE machining parameters already entered into Counter to enter into CONE function

Cone- cone measurement function

- d) After the cone measurement angle have been entered into the readout, the X axis zero will move as the Z axis travel at -20 degree.

A) zero the dial indicator on one end of the work piece

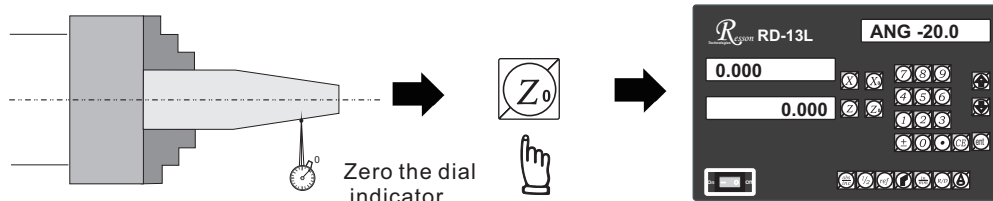

since in INCL mode, the X display is set according to $Z \cdot \tan(\text{ANG})$, therefore, zeroing the Z axis also clear the X axis.

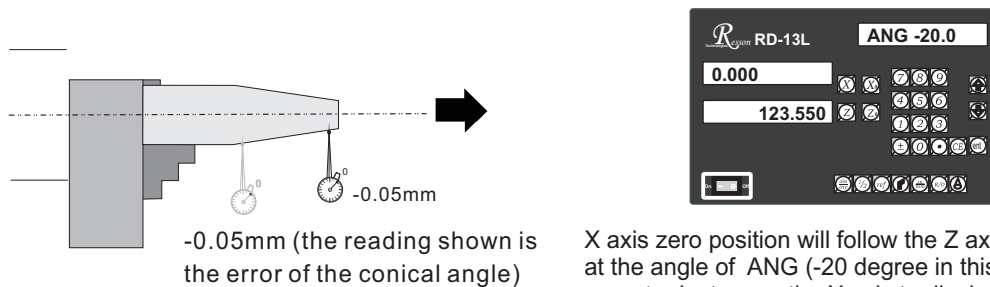

X axis zero position will follow the Z axis position at the angle of ANG (-20 degree in this example) operator just move the X axis to display =0.000 it is then at highly accurate -20 degree position to the Z axis

- B) After move the machine along the Z axis, the X zero position will automatically set at -20 degree to the Z axis. By moving the X axis position to zero ($X=0.000\text{mm}$), then the dial indicator will display the error of the conical work piece from a true -20.0 degree.

User then make a fine adjust to the top slide angle to make a closer cut to achieve a better cone angle accuracy.

Repeat the above procedures d) until satisfactory cone angle accuracy achieved.

Cone- cone measurement function

Anytime the operator want to check or verify if Counter's CONE calculation correct or not, or want to temporarily exit the CONE function cycle (swap to normal XZ display). Operation are as follows:

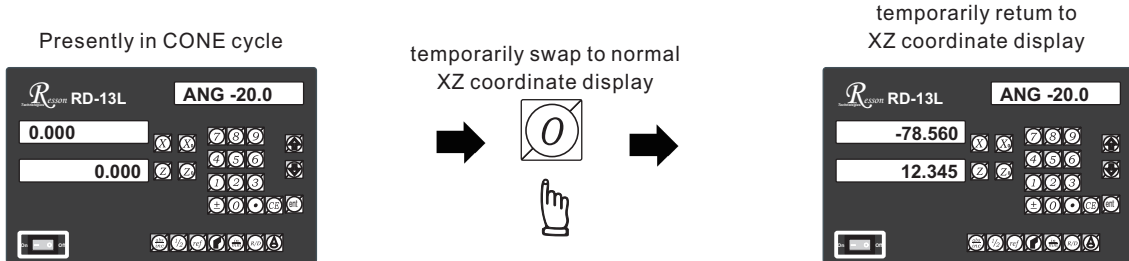

swap back to CONE cycle to continue the **INCL** incline angle alignment

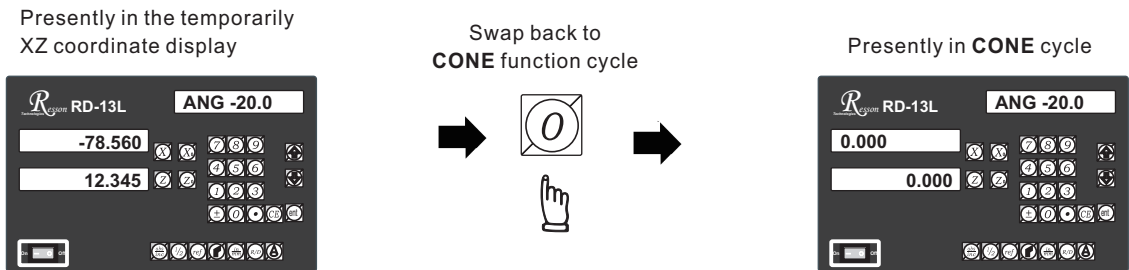



RD-13L
Digital Readout Setup Function

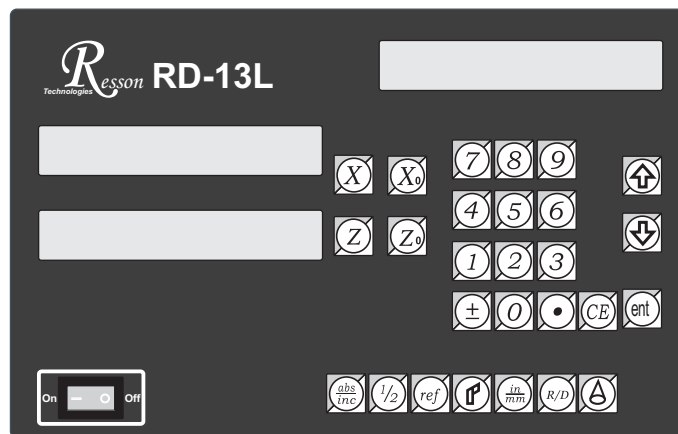

DIRECTIN specifies the direction of count for each axis
LIN COMP permits linear error compensation to be input
QUIT exits the SETUP function to proceed to normal working

RD-13L ORIGINAL PARAMETER RESET FUNCTION

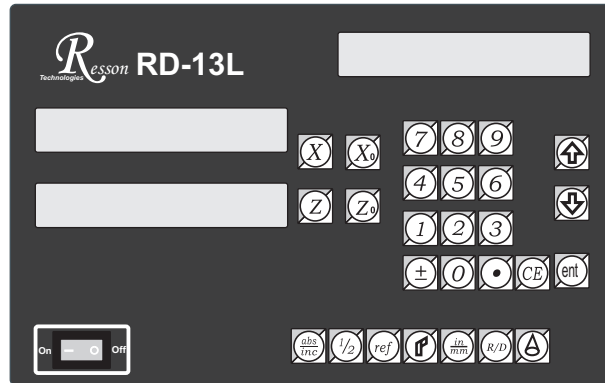

Some inscrutable cases or improper operations cause the chaos of parameter, then you need to initialize the parameter to reset the system.

Operational procedure :

- (1) Turn off the DRO.
- (2) Power on DRO once again, when "VER.**" moving in display window, please press "8" key then DRO enters into the RESET function.

power on the DRO, then DRO starts the self-test function

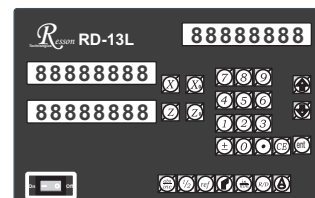

when "VER.9LA" appears in display window, please press " 8 " key.

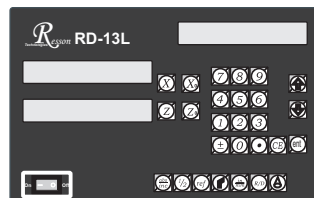

when some messages are displayed over, the DRO enters into the RESET function.



Digital Readout Setup Function

(3) When enter into the RESET function, DRO will display :

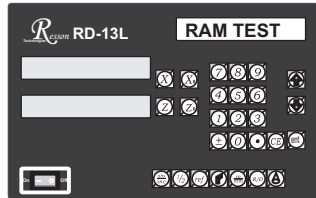

display "RAM TEST" that means the RAM is testing

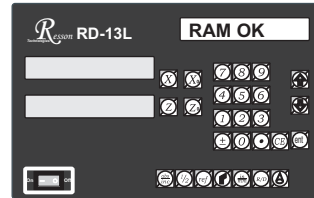

if the RAM function is normal , DRO can display "RAM OK"

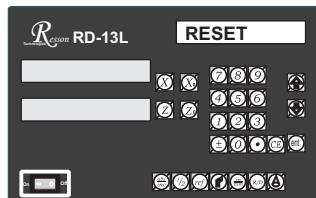

display "RESET" that means the parameter has reset

(4) The reset of parameter has completed then start to enter into the test procedure of display light.

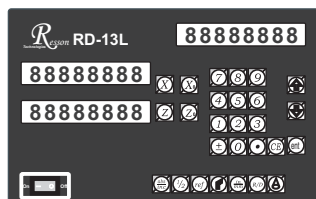

(5) Turn off the DRO after complete the reset, then power on the DRO once again.

RD-13L SETUP FUNCTION

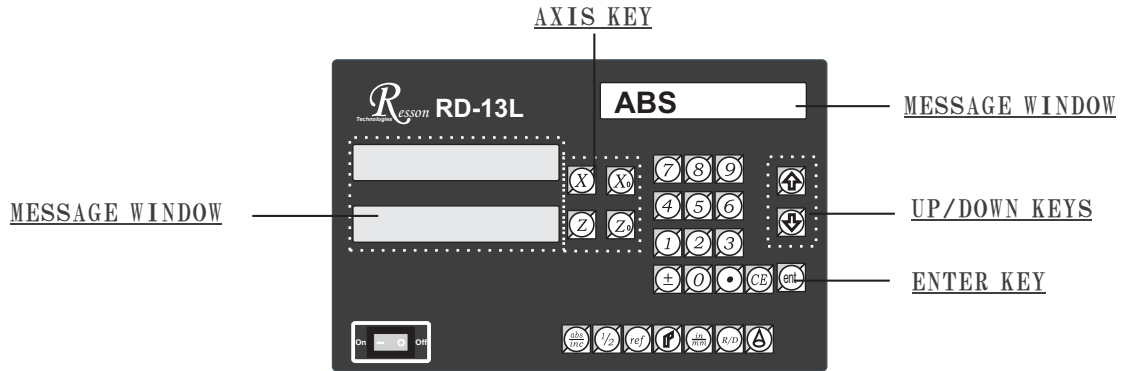

During changing the different program version IC or some abnormal voltages and operations, you need to SETUP the DRO.

Procedure :

- 1). Turn off the DRO.
- 2). Power on the DRO once again, when the message "VER.9LA" showing in the MESSAGE WINDOW, please Enter key immediately then the DRO starts entering into the SETUP function.

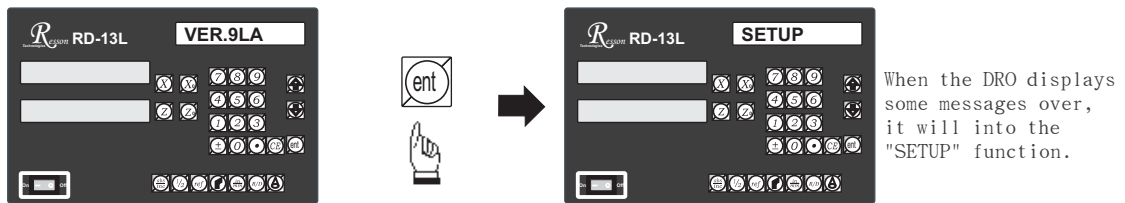



The SETUP procedure is written in a menu mode which enables you to scroll through the top level options and enter, configure and exit the sub-functions as they arise.

The top level menu headers in order are as follows :

- | | |
|----------|---|
| DIRECTIN | specifies the direction of count for each axis |
| LIN COMP | permits linear error compensation to be input |
| QUIT | exits the SETUP function to proceed to normal working |

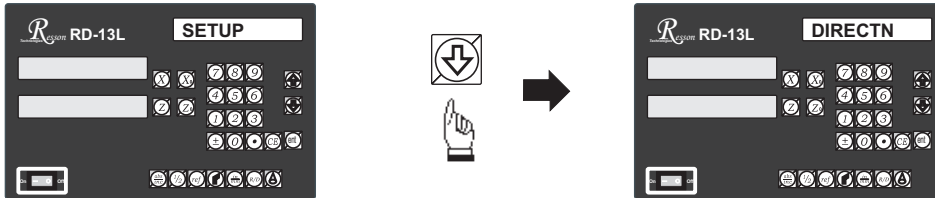

Digital Readout Setup Function

- 3.) Press  key to select the "DIRECTN" (counting direction) function. Press  key to return to the last function.



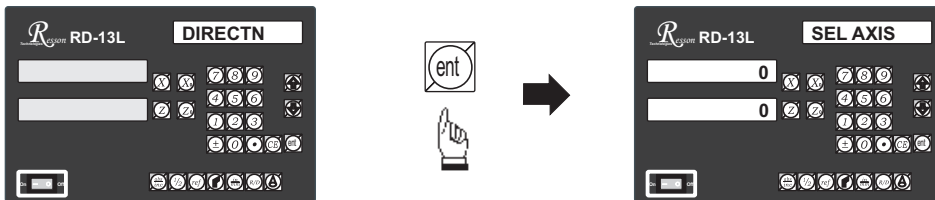

- Press  key into the direction setting function, the 0 represents a positive, 1 represents a negative.

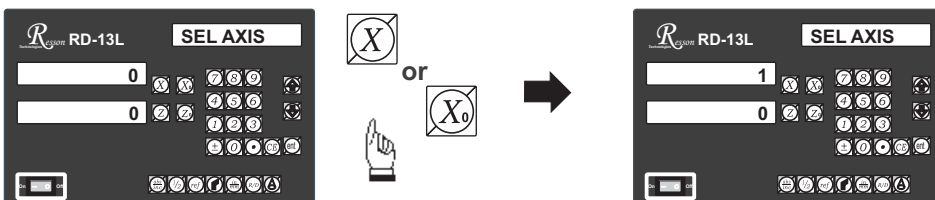

- Press  or  key to set up a negative direction "1" for X Axis, make a same procedure for Y Axis.



- 4.) Press  key to make your setting, then press  key to select the "LIN COMP" (linear compensation) function.

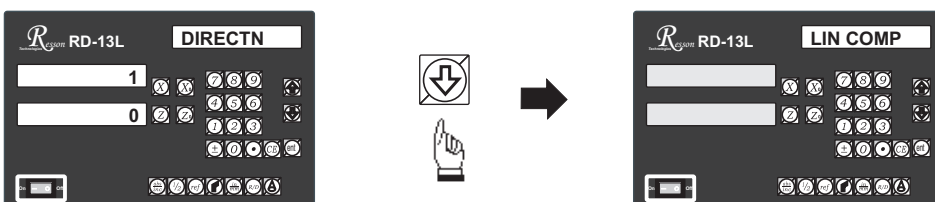



Press  key into the linear error compensation function, the formula as below..
 error value X $-(1000/\text{measuring length}) = \text{compensation value}$
 (ML) measuring length unit = mm, error unit = μm
 Example..

$$\begin{aligned} \text{ML} &= 500\text{mm} & \text{Error} &= -15\mu\text{m} \\ -15\mu & \times -(1000/500) & &= 30\mu\text{m} \\ & & \text{the compensation value is} & 30\mu\text{m} \end{aligned}$$

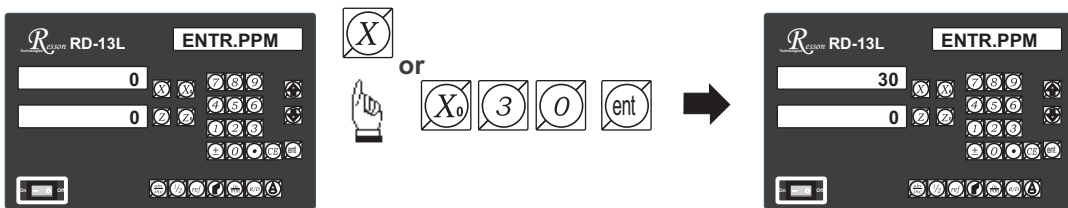
If set up the linear compensation value of X Axis = 30, through the AXIS key make a same procedure for Y Axis.



5.) Press  key to make your setting, then press  key to select the "QUIT" function.

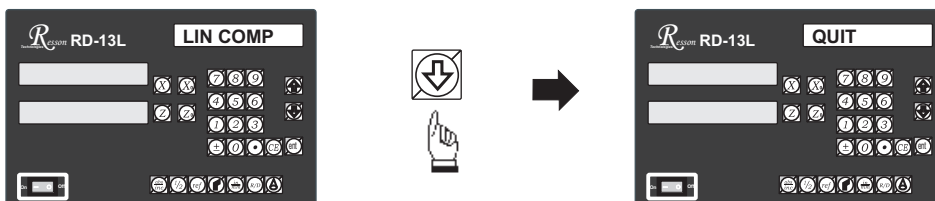

Press  key to make your selection, then the DRO will exit the SETUP function and return to the "ABS" state.

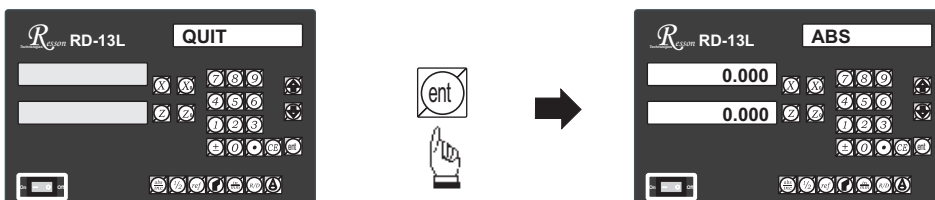

By pressing the ENTER key the DRO exits the SETUP program and is ready for machining operations. If use the error compensation function, you must turn off the DRO then power on the DRO again, otherwise your compensated value will invalid.

RD-13L Specification

RD-13L Specification :

Number of axes : 1、2

Resolution : 0.005mm

Display function : 8位 LED 發光管

Response speed : 60m (198.6feet)/min

Quantizing error : \pm count

Power source : AC100V~230V / 50~60Hz / 20VA

Temperature fange : Service:0~40℃ / Storage:-20~70℃

Linear Encoter (Scales) Electrical connector :

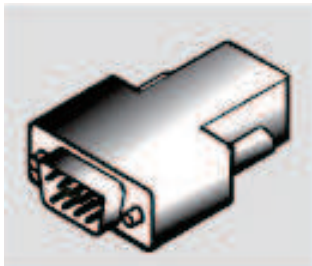

D-sub 9 pins connector

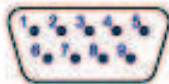

PIN	SIGNALS
1	N/C
2	0V
3	N/C
4	Inner shield
5	N/C
6	A
7	5V
8	B
9	R

N/C : No Connection



DIN 7 pins connector



PIN	SIGNALS
1	0V
2	N/C
3	A
4	B
5	5V
6	R
7	Inner shield

N/C : No Connection

